

Catalogue

Dear user:

Welcome to using QP-40B online dynamic outer diameter measurement controller. As a solution provider of online measurement, control and statistics, QiPang Technology adheres to the tenet of “quality first and customer oriented” and serves you wholeheartedly. If you have any requirements or suggestions, please contact us in time (contact means: +8615001830288), we will provide you with timely services according to your needs.

If you use it for the first time, please do carefully read “Operating Manual”.

I . Instrument Introduction -----	2
1-1 Overview-----	2
1-2 Technical parameters-----	4
II. Operating Principle -----	5
III. Operation Panel -----	5
3-1 Function layout-----	5
3-2 Definition of function code-----	6
3-3 Operation flow chart of function code-----	9
IV. Remote Display -----	11
V. Remote Controller -----	11
5-1QP-05X(two-dimension mode) -----	11
Function layout-----	11
VI. Use -----	13
6-1 Installation-----	13
6-2 Feedback control-----	13
6-2-1: Installation position-----	13
6-2-2: Control cable-----	13
6-2-3: Control parameter-----	14
6-2-4: Control debugging-----	15
6-2-5: Instrument status-----	16
VII. Communication -----	16
7-1 Communication Format-----	16
7-2 MODBUSRTU-1 communication format-----	18

7-2-1: Information Frame Format-----	18
7-2-2: Start Structure And End Structure-----	18
7-2-3: Address Code-----	19
7-2-4: Function Code-----	19
7-2-5: Data Area-----	19
7-2-6: Exceptional response frame-----	19
7-2-7: CRC check-----	20
7-2-8: Example of information frame-----	21
7-2-9: Register address assignment-----	21
7-3 MODBUSRTU-2 communication format-----	22
7-3-1: Start Structure And End Structure-----	22
7-3-2: Address Code-----	23
7-3-3: Function Code-----	23
7-3-4: Data Area-----	23
7-3-5: CRC verification-----	24
7-3-6: Abnormal response frame-----	25
VIII. Overall Dimension -----	27
IX. Maintenance -----	29
X. Accessory -----	29
XI. After-Sales Service -----	29

I. Introduction of Instrument

1-1 Overview

QP-40B Laser Diameter Gauge, professional non-contact dynamic diameter measuring instrument, is suitable for online diameter measurement of round workpieces such as:

optical fiber and cable, electric wire & cable, glass tube, plastic tube and bearing. It not only measure display diameter and deviation value but also could control diameter automatically according to user requirement to keep consistency of wire diameter.

- Suitable for online measurement of any round wires and workpieces.
- Non-contact measurement, high-speed inspection, high precision and stable performance.
- With F θ optical lens, there is small influence of shaking on measured wire.
- With inbuilt PID control module, wire diameter can be automatically controlled.
- With all-dimensional revolving operating panel, long-distance displays of various dimensions are equipped.
- With multi-address RS232/485 communication interface.
- With semiconductor laser of long service life.
- With Switzerland brushless DC motor, it could be adapted to working under severe environment.

QP-40B Laser Diameter Gauge adopts a two-dimensional measurement mode, and the two-dimensional Laser Diameter Gauge measures the diameter value of the workpiece in two directions. Its structure is compact, and it has the same operation function and output interface. It consists of a laser measuring head, an operation panel, and a remote controller, and can be extended to connect various sizes of remote displays, as shown in the following figure.

The measuring instrument is equipped with high-precision laser scanning system and embedded digital processing circuit. The diameter signal produced by the scanning system is firstly converted into digital signal to obtain practical diameter value and related data through series of calculations and processing. The output interface of diameter measuring instrument contains 1 485 communication interface and 2 synchronic serial ports. The data of diameter measuring instrument could be transmitted to PC or remote controller through 485 communication interface. It can be connected with operation panel and remote controllers and displays of various dimensions through synchronic serial port to realize remote control and display.

Operational panel is installed above measuring head. It is used for setting parameters of data display. There are two rows of nixie tube, which could display two groups of data and adjust angle at random.

Remote controller is mainly used for automatic control. It receives data including the diameter and deviation value of diameter measuring instrument through synchronic serial port and 485 communication interface. Remote controller generates PID regulatory signal through data it receives to control the rotating speed of tractor so as to finally control wire diameter.

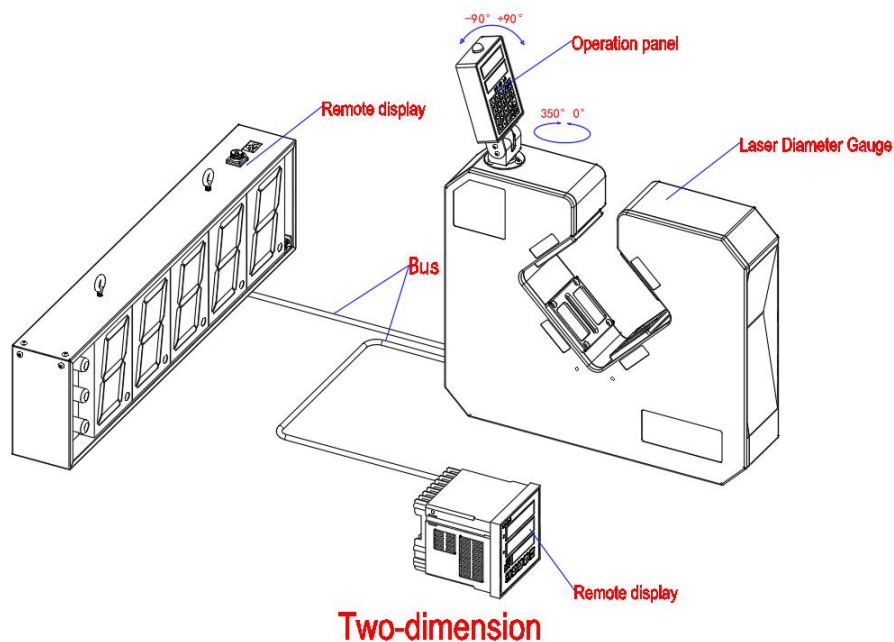

1-2 Technical parameters:

Output voltage of control interface:	-10V ~ +10V
Maximum output current:	5mA
Scan speed:	1400 scan cycles/sec
Display means:	Double row 5-digit digital tube display
Work principle:	Non-contact laser scanning
Light source:	Second generation visible laser, wavelength 650nm
Communication means:	Communication method: use RS485 interface to communicate with other devices (communication protocol: 1.ASC II code protocol; 2.MODBUS RTU protocol)
Data collection and analysis:	Support (require an external computer and installation of related software)
Over-tolerance alarm function:	Double relay contact output, upper Lower deviation signal output separately (external sound and light alarm DC24V and below)
Power supply:	220VAC±10%50/60HZ
Product consumption:	≤15W
Work height:	850 ~ 1100mm
Ambient temperature:	0 ~ 45°C
Ambient humidity:	35-85%(no condensation)
Other environment requirement:	The air does not contain any corrosive gas, serious volatile oil, water vapor and dust.
Product protection:	IP65

II. Operating Principle

The light beam generated by laser is irradiated on the revolving prism. The light beam irradiated by the prism becomes the one in parallel motion through lens 1 while the parallel light beam will be converged on the receiving element. Please refer to the Fig. 2. When the tested object on the focal plane of lens 1, part of light ray is shield, thus the shadow is generated. As a result, the corresponding electric signal is generated on receiving element. The diameter value and a series of related signals are obtained after the signal is processed with diameter measuring instrument. .

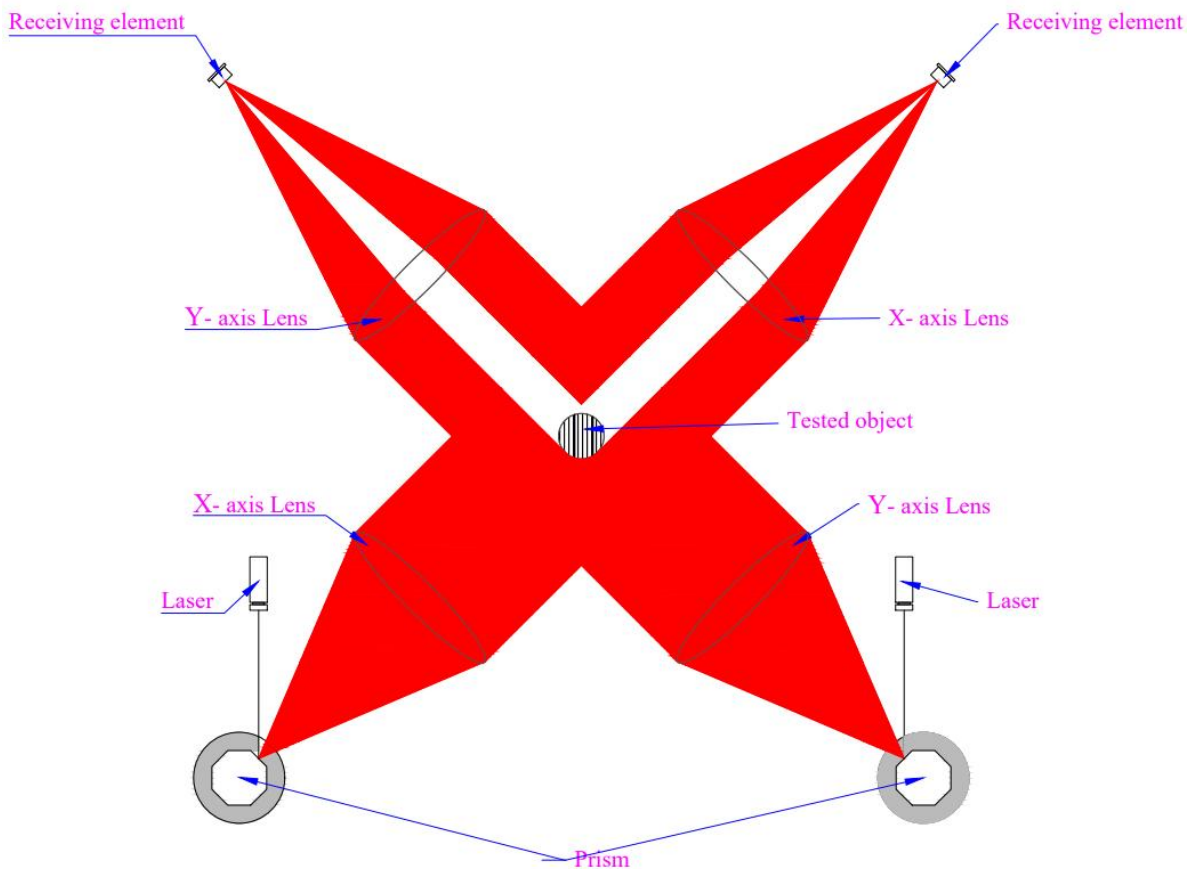

III. Operation Panel

3-1 Function layout:

The operation panel is installed above the measuring head as shown in the figure above. The operation panel is used for data display, parameter setting, out-of-tolerance indication and alarm.

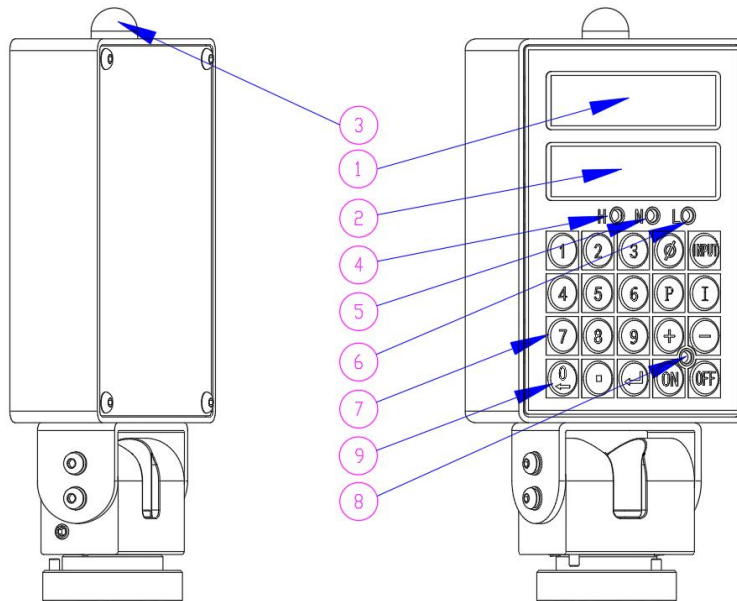

1. X-axis display window 2. Y-axis display window 3.. Alarm indicator
 4. Upper out of tolerance indicator 5. Normal indicator 6. Down out of tolerance indicator
 7. Operation keys 8. Input indicator 9. 0 is the shift key

Notes:

1: When setting X and Y alarms separately, upper-deviation indicator lamp indicates X measurement value alarm while lower-deviation indicator lamp indicates Y measurement value alarm.

2: When measuring the jitter value, the upper-deviation indicator lamp indicates measurement value alarm of outer diameter while lower-deviation indicator lamp indicates measurement value alarm of jitter.

3: When measuring ovality, the upper-deviation indicator lamp indicates measurement value alarm of outer diameter while lower-deviation indicator lamp indicates measurement value alarm of ovality.

4: When measuring inner diameter of glass, upper-deviation indicator lamp indicates measurement value alarm of outer diameter while lower-deviation indicator lamp indicates measurement alarm of inner diameter of glass.

5: When measuring maximum and minimum size or length and width, the main display screen displays maximum size or length while the sub display screen displays the minimum size or width.

3-2 Function parameter definition

Code(main display)	Name of the function code	Model	Set range	Delivery value
1	Average times preset	General	1 ~ 999(The smaller the value, the higher the sensitivity)	20
2	Communication address preset	General	0 ~ 128	1
3	Communication baud rate preset	General	0 - 9600	0
			1 - 19200	
			2 - 38400	
			3 - 57600	
4	Sound and light alarm switch	General	0 - close	0

			1 - open	
5	Shrinkage ratio	General	50% ~ 100%	100
6	Sub display item selection	One-dimension	0 - deviation value	0
			1 - position value	
			2 - maximum value	
		Two-dimension	0 - average deviation	0
			1 - ellipticity	
			2 - X axis diameter	
			3 - Y axis diameter	
			4 - X axis deviation	
			5 - Y axis deviation	
			6 - X axis position	
			7 - Y axis position	
7	PID output polarity selection	General	0 - positive	0
			1 - negative	
9	Alarm selection	General	0 - average diameter	0
			1 - X axis diameter	
			2 - Y axis diameter	
10	Diameter value preset When the X and Y diameters are separated, set the value for the X diameter.	QP-25	0.100 ~ 27.000	5.000
		QP-40	0.200 ~ 42.000	10.000
		QP-70	1.00 ~ 72.00	50.00
		QP-100	1.00 ~ 100.00	70.00
		QP-200	1.00 ~ 200.00	100.00
11	X positive axis tolerance	General	0.001 ~ 5	0.05
12	X negative axis tolerance	General	0.001 ~ 5	0.05
13	P value	General	0 ~ 200	18
14	I value	General	0 ~ 10	5
18	Communication format settings	General	0 - default communication format, no	0
			1 - Default communication format, odd parity	
			2 - Default communication format, even parity	
			3 - MODBUSRTU-1, RTU-2 no parity	

			4 - MODBUSRTU-1, RTU-2, odd parity	
			5 - MODBUSRTU-1, RTU-2, even parity	
20	Display digital refresh frequency	General		6
21	Main display item selection	Two-dimension	0 - average diameter	0
			1 - X axis diameter	
			2 - Y axis diameter	
22	Analog output	General	0 - PID	0
			1 - deviation amount	
25	Diameter value preset When the X and Y diameters are separated, set the value for the Y diameter.	QP-25	0.100 ~ 27.000	5.000
		QP-40	0.200 ~ 42.000	10.000
		QP-70	1.00 ~ 72.00	50.00
		QP-100	1.00 ~ 100.00	70.00
		QP-200	1.00 ~ 200.00	100.00
26	Y positive axis tolerance	General	0.001 ~ 5	0.05
27	Y negative axis tolerance	General	0.001 ~ 5	0.05
28	Metric and imperial options	General	0-metric, 1-imperial	0
41	X diameter small adjustment	General	0.000 ~ 0.200	0.100
42	Y diameter small adjustment	General	0.000 ~ 0.200	0.100
99	Reset	General	0 - no change, 1 - default value	0

3-3 Flow chart of menu setting

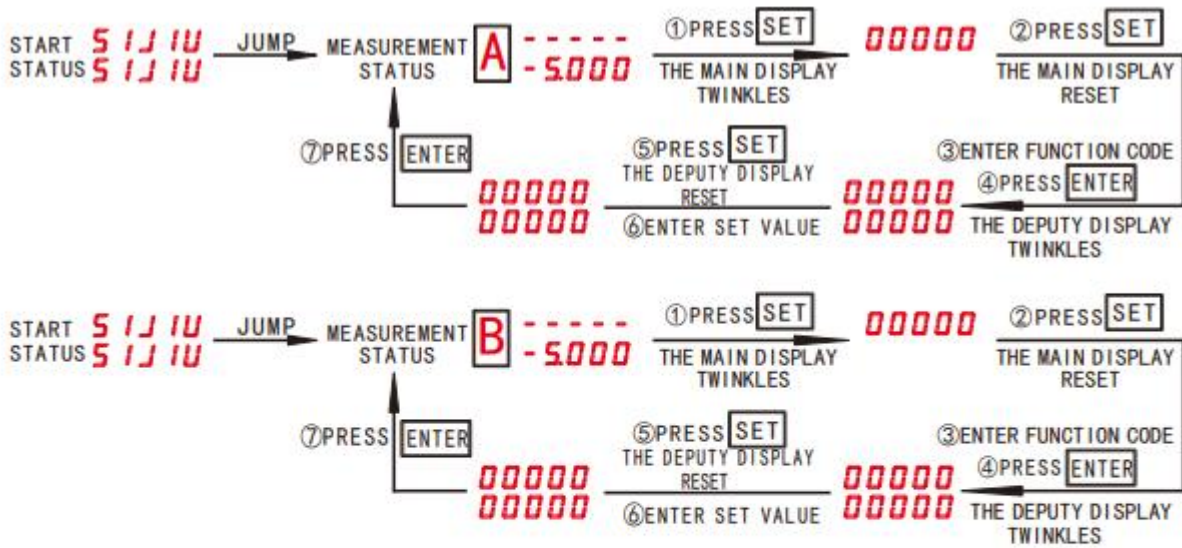

**Refer to 3-2 Function Code Definitions for function codes.

Flow chart of average sampling times setting

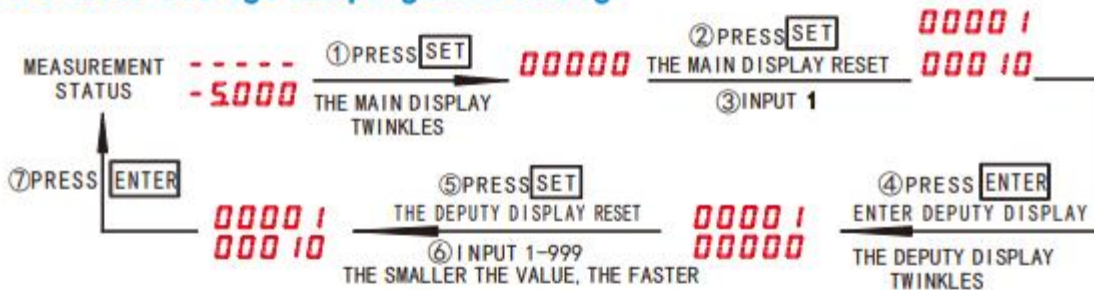

Flow chart of communication address setting

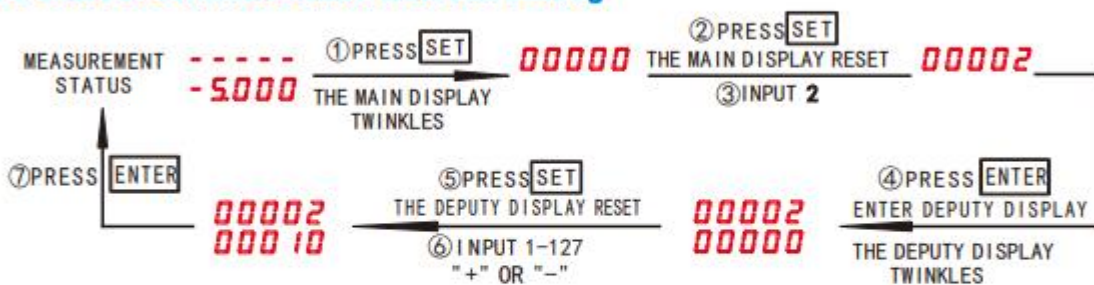

Flow chart of baud rate setting

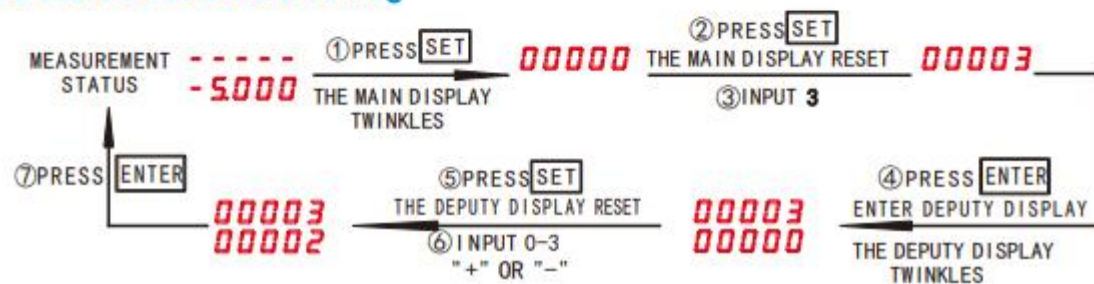

Flow chart of communication format setting

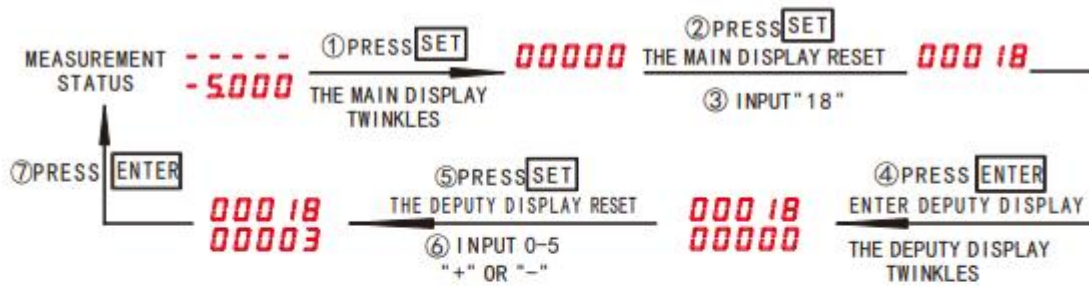

Flow chart of diameter fine adjustment (X-axis, Y-axis) setting

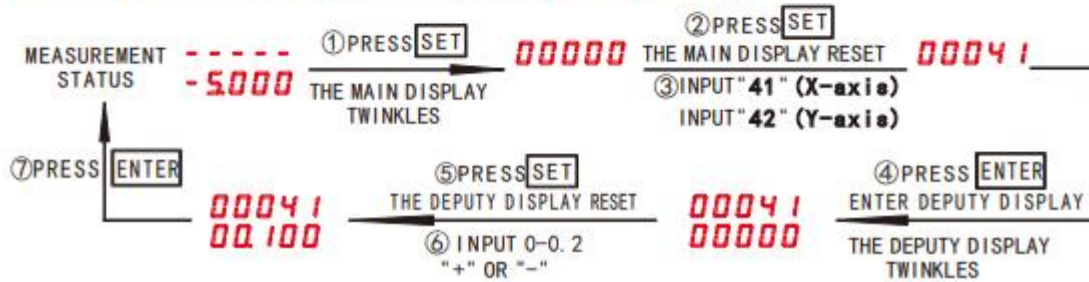

Flow Chart of Diameter Preset Setting

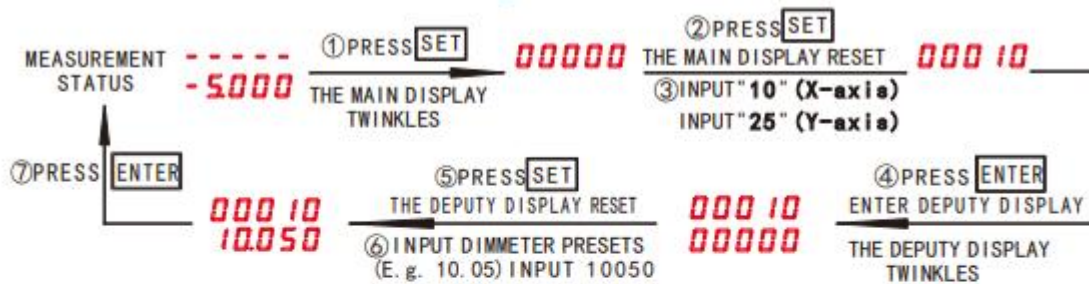

Flow Chart of Positive and Negative Tolerance Preset Setting

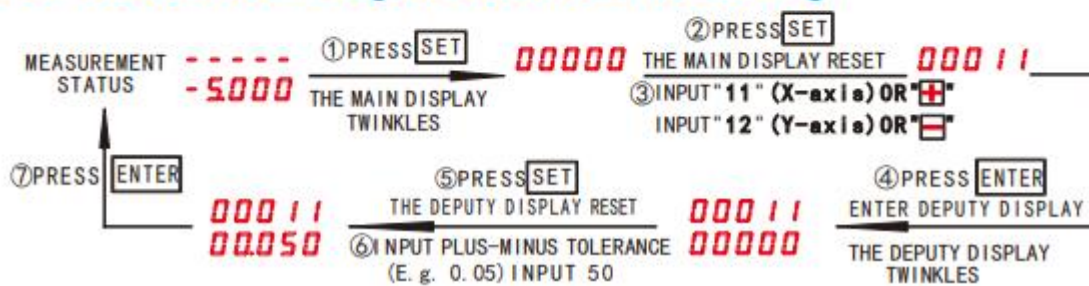

IV. Remote Display

QP-03/X Remote display is used for long-distance displaying. The transmission distance could reach 200m. The connecting line is provided by the user.

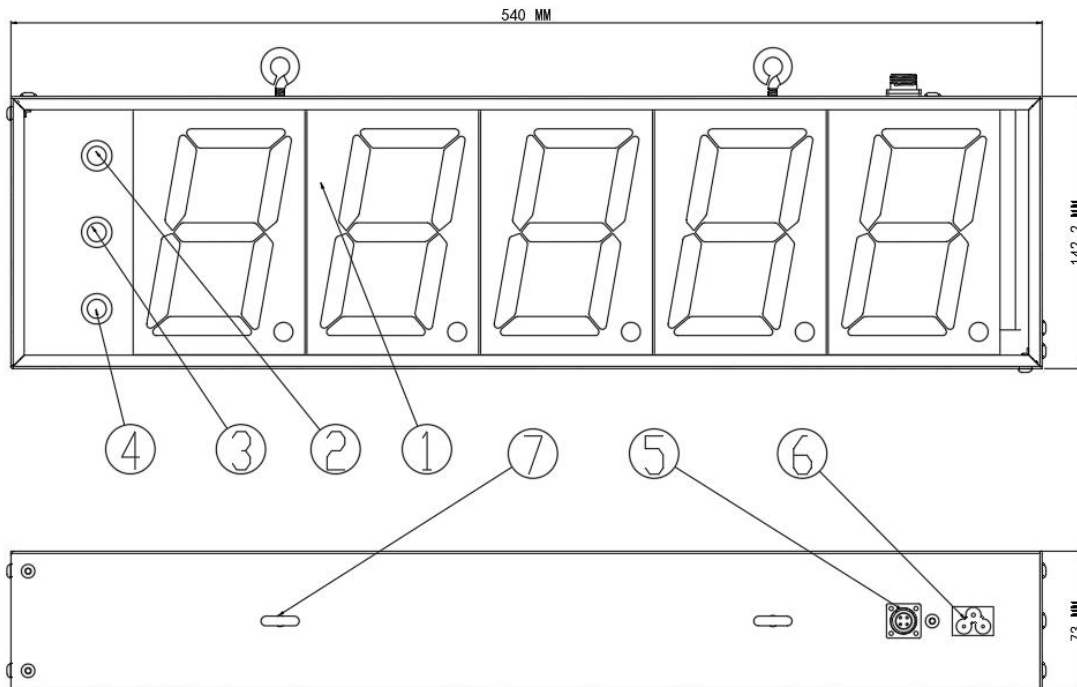

1. Display window 2. Upper out-of-tolerance indication 3. No out-of-tolerance indication 4. Down out of tolerance indication 5. Synchronous serial port connected to measuring head 6. 220V power supply 7. Installation hook

V. Remote Controller

The remote controller (QP-04/X) is connected to the outer diameter measurement controller through synchronous serial port 2, and then controls the screw speed or traction motor speed of the extrusion machine based on the deviation between the measured wire diameter and the set nominal value, so that the actual wire diameter is as close as possible to the nominal value, achieving automatic control of the outer diameter and maintaining wire diameter consistency.

5-1 QP-05/X (two-dimension mode)

Function layout, wiring means, opening size

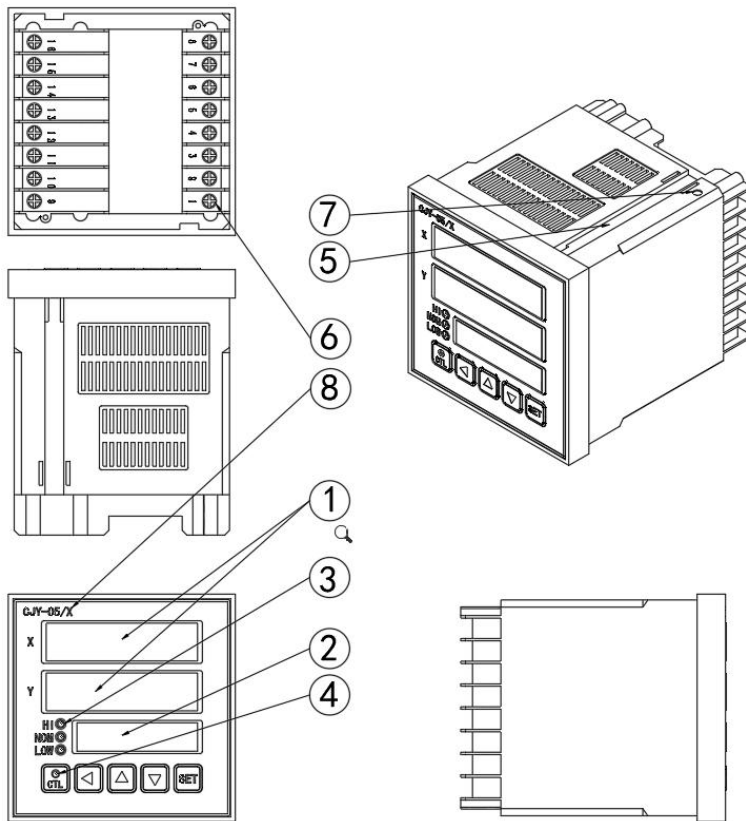

1. XY axis Display window
2. Sub Display window
3. Alarm light
4. Input indicator
5. Installation bracket groove
6. Wiring terminal
7. Output calibration
8. Model

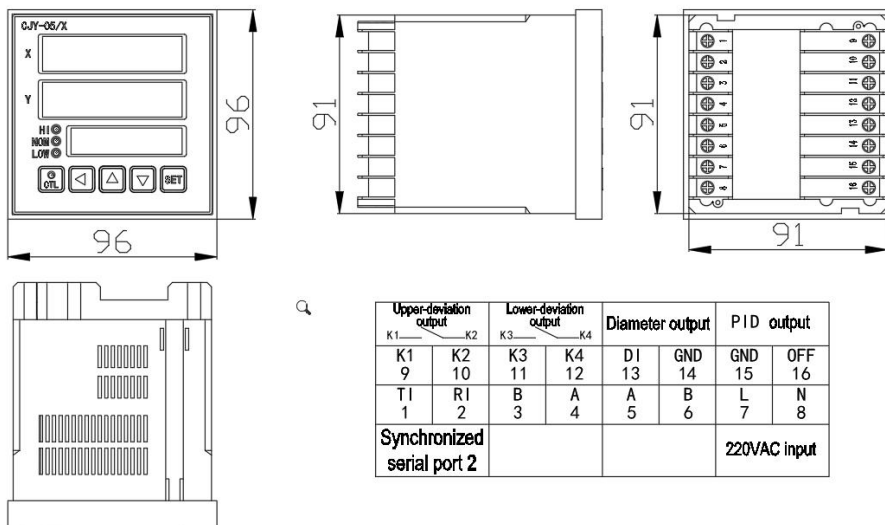

Analogue output:

two independent 12-bit D/A output (photoelectric isolation), output impedance is 100Ω.

1. Diameter output: 0~10V (10V corresponds to full scale)

2. Deviation/ PID controlled quantity: ±0.2V~2.3V, which is adjustable and can be regulated to ±2 V when leaving the factory.

3. When adjusting PID, adjust the voltage range of 0.5 ~ 8.0V: press the rightmost key to enter the voltage adjustment mode, press the up key or down key to adjust the voltage, and then press the rightmost key to exit.

Over-deviation alarm: relay output.

Synchronized port : **remote controller should be connected.**

485 communication interface (connected to the measuring head): according to the table

3. 1-A and 2-B , **it is necessary to connect when require 485 communication.**

485 communication interface (connected to PC): 16-A , 15-B .

VI. Use

6-1 Installation

(1) Open the package, and check whether the instruments and accessories are complete according to the packing list.

(2) Install the measuring head on the bracket and tighten and fasten the screw.

(3) Put the measuring head in proper location on production line, move the bracket to have the tested cable aligned to the center of groove of guide roller, prepare foot screw and fasten the measuring head on production line.

(4) Loose the tightening screw, and lift measuring head to have the cable touch the bottom of groove of guide roller and have little pressure when working normally, and then tighten the screw.

(5) Plug the power cable into power socket and tighten it and connect the power, and then the instrument will begin to work.

6-2 Feedback control

Laser measuring head and remote controller can constitute feedback control system, which can adjust the speed of tractor and extruder according to the deviation of diameter and dynamically adjust wire diameter. Now, the explanation is given by taking the control of production line of electric wire and cable for example, follow this one to finish other applications.

6-2-1 Installation position

QP laser diameter measuring instrument can be installed in front of cooling water tank. The feedback on change in wire diameter is immediately given and it is favorable for controlling. However, the measured diameter is the thermal state value of the wire. There is certain error between it and cooled actual value. Additionally, due to high outlet temperature, soft sheath of wire, the guide roller cannot be installed and the wire can jitter easily. After the diameter measuring instrument is installed after cooling water tank and dryer, the measured value is actual value after cooled and molding. However, the delayed feedback on change in wire diameter will influence the precision. The remote controller is generally installed on electric cabinet and connected with diameter measuring instrument through power cable.

6-2-2 Control wiring

1) Firstly, cut off the power of diameter measuring instrument, remote controller, tractor and plastic extruding machine.

2) Turn on the controller of tractor or plastic extruding machine (DC adjustable-speed motor or frequency converter).

3) Cut or solder off the connection on the middle tap of the potentiometer of the traction host, and connect the PID output GND15 pin of the remote 04X controller to the middle tap of the potentiometer of the traction host. Connect the cut or soldered wire to the PID output OFF16 pin of the remote 04X controller, as shown in the figure below.

6-2-3 Control parameters

The **P** and **I** parameters of remote controller decide the stability of control. The defaulted parameters could work well under most situations. When the control is too slow or non-stable with defaulted parameters, user should adjust these parameters:

P Proportionality coefficient indicates the proportional action of regulator; the value is 00-200. The higher the **P** value, the faster the regulating effect. However, it is not stable. The oscillation could be easily caused. Contrarily, the lower the **P** proportionality coefficient the slower the regulating effect but stable.

I Integration coefficient decides the ability of the system to eliminate error in outer diameter. The value is also 00—10. The larger the integration coefficient **I** the stronger the ability to eliminate the error. However, if it is large excessively, the system will not be stable. The wire diameter will greatly fluctuate. The smaller the integration coefficient **I** the weaker the ability to eliminate the error. If the integration coefficient is 0, the feedback control will doesn't work.

For the input of control parameters **P** and **I**, the modification method is as below (default standard: P = 18, I = 5)

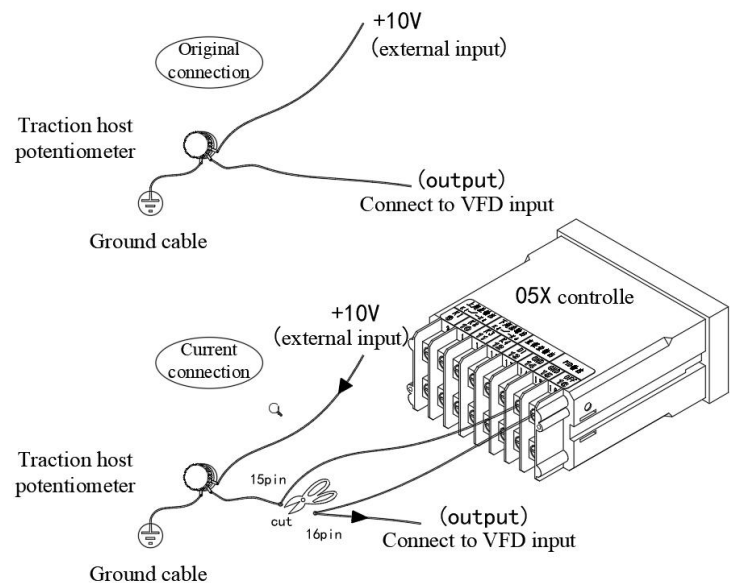

- 1) Press key **P** or **I**, the display will display the original P or I value;
- 2) Press key **INPUT**, the main display displays "0" and flashes. Press number keys "0" and "9", set parameter **P** or **I** one by one.
- 3) Press enter key, then the main display will display the P value or I value to be set.
- 4) Press enter key again, then the instrument will substitute new P value of I value for the original one. In the meantime, it automatically returns to the normal measuring





status  then P value of I value will be set.



6-2-4 Control debugging

After the feedback control line is connected, debug according to the following steps

- 1) Set nominal value
- 2) Set control parameter as P value: 24; I value: 16.
- 3) Prepare two wires, in which one is thinner than the one with nominal value set and the other is thicker than the one with nominal value set. For example. The nominal value is 0.720mm, the one is 0.5mm and the other is 1mm.
- 4) Don't pass through copper core, but start revolving of the motor at low speed correspondingly (control extruder is screw motor. It is traction motor when the wire speed is controlled.)
- 5) Press  key and connect outer diameter control, then place thick and thin wires on guide roller of outer diameter measuring and control instrument to observe the change in revolving speed of motor and see whether it is consistent with requirement. For example, when plastic extruder screw speed is controlled, if the thin wire is put, the motor speed will be reduced. When thick wire is put, the motor speed is increased. Then, the requirement will be met. If contrarily, when the thin wire is put, the motor speed will be reduced. However, when the thick wire is put, the motor speed will be increased. Then, the requirement will not be met. If it is found that the motor speed doesn't meet requirements, the two wires of control voltage output can be exchanged.
- 6) Press  key, cut off outer diameter control and then start up and implement trial run.
- 7) Regulate the production line stably and observe the change process of outer diameter. After it is stable, press  key and connect outer diameter control, then three kinds of circumstances will emerge possibly.

Situation 1: The wire diameter will approach the set nominal value (error is within 1%) (about 20 seconds), and there is no obvious fluctuation phenomenon. Then, the adjustment will be completed.

Situation 2: The wire diameter will approach the set nominal value slowly. However, the time is long (more than 2min). Then, it is necessary to increase the proportionality coefficient  and integration coefficient  at this time.

Situation 3: outer diameter fluctuates drastically and cannot reach stable status. At this time, it is necessary to reduce the proportionality coefficient  and integration coefficient . Repeatedly modify proportionality coefficient and integration coefficient

until the situation 1 occurs. Then, the adjustment will be finished.

6-2-5 Notes for control

1) when outer diameter feedback control is used, its feedback control effect is only to provide "fine tuning" to the outer diameter. Therefore, it is necessary to adjust the coarse tuning of wire diameter to be near to the set value and state  press the key of controller and connect outer diameter control.

2) The effect of outer diameter feedback is to control the average value of outer diameter of wire on the set value. It cannot eliminate the fast change of outer diameter of wire, which is guaranteed by the stability on the production line.

3) If there is water in tested wire, the measured result includes the outer diameter value including water film on the surface. It is larger than the outer diameter of dry wire (about one wire). At this time, it is necessary to slightly increase the nominal value according to the practical experience.

6-2-6 Instrument status

* Normal state

1) Main display displays the outer diameter of tested object. The display range is: 00.000 mm~25.000mm;

2) Sub display displays deviation value (by modifying the parameter, the position value and jitter value can be displayed);

3) When the outer diameter value is within allowed tolerance range, the indicator lamp  is on, which indicates the wire is normal.

4) When the outer diameter value exceeds the upper tolerance, the indicator lamp  is on, which indicates the wire is too thick.

5) When the outer diameter value exceeds the lower tolerance, the indicator lamp  is on, which indicates the wire is too thin.

6) When automatic feedback control is opened, the indicator lamp  will be on, which indicates the feedback is opened.

7) When automatic feedback control is closed, the indicator lamp  will be on, which indicates the feedback is opened.

*Abnormal state

The main display show  , it indicates that the instrument has an error.

VII. Communication

Data format: 1 start bit, 8 data bits and 1 stop bit. Odd-even check can be selected by pressing Code 18 parameter.

7-1 communication format

Standard asynchronous serial interface is adopted for bus of controller and RS232/485 of remote controller. The real-time diameter value can be obtained and internal parameter

can be modified through this interface (please refer to the following table).

Read parameter: address parameter

Laser Diameter Gauge output: address & parameter two bits data and the high-order comes first, CRC is check code.

Write parameter: address & parameter two bits data and the high-order comes first, CRC is check code.

CRC check code is the result value (1 bit) of all bits. 8-bit CRC code of CCITT will be adopted for CRC. Its generator polynomial is $G(x)=X_8 + X_5 + X_4 + 1$.

Example 1: read diameter value

Assuming the address of Laser Diameter Gauge is 1 (01 H). When the current diameter is 6.234 (185aH), then:

Input: 01H41H

Laser Diameter Gauge output is: 01 H 4 1 H 1 8 H 5 a H C R C code

Example 2: read position value

Assuming the address of Laser Diameter Gauge is 1 (01 H). when the current position value is -05, then:

Input: 01H44H

Laser Diameter Gauge output is: 01 H 4 4 H F F H F B H C R C code

Example 3: write reference diameter value

Assuming the address of Laser Diameter Gauge is 1 (01 H), the reference diameter value will be changed into 60.00 (1770H), then:

Input: 01H 66H 17H 70H CRC code

CRC calculation example: CRC code

Sending address: sci_txt[0]=01H; sending parameter: sci_txt[1]=41H

Sending data is higher than 8 bits: sci_txt[2]=18H; sending data is lower than 8 bits: sci_txt[3]=5AH. CRC value to be calculated: sci_txt[4]=2AH

Subroutine of Verify_CRC8 is as below:

n: indicates number of bit calculating CRC; crc: indicates initial CRC value; *p: indicates the data address of CRC.

```

unsigned char Verify_CRC8(unsigned char n,unsigned char crc,unsigned char *p){
unsigned char i,j,crc_buf;
for(j=0;j<n;j++){
  crc_buf=*p++;
  for(i=0;i<8;i++){
    if(((crc input+crc_buf)&0x01)==0){//same lowest position
      crc>>=1;
    }else{//different lowest position
      Crc input+=0x18;
      crc>>=1;

```

```

crc|=0x80;
}
crc_buf>>=1;
}
}
return(crc);
}

```

The reference of reading other parameters:

Read		Write		One-dimension	Two-dimension
ASCII	Hexadecimal	ASCII	Hexadecimal		
A	0X41	-----	-----	Read diameter	Read average
B	0x42	-----	-----	-----	Read X-axis diameter
C	0X43	-----	-----	-----	Read Y-axis diameter
D	0X44	-----	-----	Read position	Read X position
E	0X45	-----	-----	-----	Read Y position
F	0X46	f	0X66	Reference diameter	Reference diameter
G	0X47	g	0X67	Upper deviation	Upper deviation
H	0X48	h	0X68	Lower deviation	Lower deviation
K	0X4B	k	0X6B	Average times	Average times
L	0X4C	l	0X6C	P parameter	P parameter
M	0X4D	m	0X6D	I parameter	I parameter
N	0X4E	n	0X6E	D parameter	D parameter

7-2 MODBUS RTU communication format

Standard asynchronous serial port is adopted for bus of controller and RS232/485 of remote controller. For communication, the master device on the bus of RS-485 firstly sends out order. When the communication order is sent to the instrument, the equipment meeting corresponding address code will receive the communication order. If there is no error, it will execute the corresponding task and send the execution result to the sender. The returned information includes: address code, function codes of execution action, the data and wrong check code (CRC) after execution action. If there is an error, it will not send any information.

7-2-1 Information frame format

START initial structure delay (transmission time with ≥ 3.5 bit)

ADDR address code 1 byte (8 bits)

CS function code 1 byte (8 bits)

DATA data area N byte (N×8 bits)

CRC wrong check 2 bytes (16 bits)

END end structure delay (transmission time with ≥ 3.5 bit)

7-2-2 Initial and end structure

Initial structure symbolizes the beginning of a data frame while the end structure symbolizes the ending of a data frame, generated by the sender of data frame. The method: reduce the bus of RS-485 to the transmission time with 3.5 bytes. All data bytes of a data frame should be sent continuously. If the interval with transmission time of 1.5 bytes emerges in certain data frame, it will be abandoned as invalid frame.

At receiving terminal, once the bus idle of 3.5-byte transmission time is detected, it assumes that a new data frame begins. However, during receiving data frame, once the bus idle of 3.5-byte transmission time is detected, it assumes that the data frame is received. If the bus idle of transmission time with byte larger than 1.5 and smaller than 3.5 during receiving the data frame is detected, the data frame will be abandoned as invalid frame. Then, the next initial structure will restart.

7-2-3 Address code

Address code is the first data byte in information frame sent by the communication every time. Standard Modbus RTU protocol supports slave address code 1-247. Allowable address code range of QP-XXJ outer diameter measuring instrument is 01-6F. It can be set through panel of instrument. For setting methods, please refer to the section 3.4.

7-2-4 Function code

Function code is the first data byte in information frame sent by communication every time. The function code defined by Modbus RTU communication protocol is 1-127 (0x01-0x7F). The following function codes are used for QP-XXJ outer diameter measuring instrument:

03 read holding register read register content with one or many continuous address

06 write single register write first 16-bit data into register

7-2-5 Data area

(1) 03 function (read holding register) data area of request frame includes four bytes:

Byte 3: initial address of register (high byte)

Byte 4: initial address of register (low byte)

Byte 5: quantity of register (high byte)

Byte 6: quantity of register (low byte)

After request order is normally executed, the returned response frame data area includes $2N+1$ bytes (N: quantity of register)

Byte 3: number of bytes of follow-up data ($=2N$)

Byte 4~3+2N: N registers' value (high byte comes first, followed by the low byte)

(2) 06 function (write single register) data area of request frame includes four bytes

- Byte 3: register address (high byte)
- Byte 4: register address (low byte)
- Byte 5: Register value to write (high byte)
- Byte 6: Register value to write (low byte)

After the request order is normally executed, the returned response frame data area is completely the same with the request frame.

7.2-6 Exceptional response frame

If the abnormality occurs to the slave when executing request order, an exceptional response frame will be returned. Its structure is:

START initial structure delay (transmission time with ≥ 3.5 bytes)

ADDR address code 1 byte, the address of slave

ES poor & error code 1 byte, = original function code +128 (decimal system) or +80h (hexadecimal)

EC exception code 1 byte

CRC error checkout 2 bytes (16 bits)

END end structure delay (transmission time with ≥ 3.5 bytes)

In which poor & error code=original function code = original function code +128 (decimal system) or +80h (hexadecimal). For example, for function request 03, its poor & error code= 83h (hexadecimal). The definition of exception code: 01= function code that is not supported; 02=wrong address of register; 03=data error; 04=execution failure

7.2-7 CRC check

Modbus RTU communication protocol, CRC is used to control transmission error.

Sender calculate CRC codes including address code, function code and data area and sent them by attaching them to the data (CRC code contains two bytes. The low byte shall be firstly sent). The receiver shall recalculate CRC check code after receiving the data frame, and compare it with the received one. If equivalent, the data frame is valid. Conversely, if not equivalent, it assumes that the data frame is invalid.

Calculation method of CRC: preset 1 16-bit register, and then calculate continuous 8 bytes in the message. Note: only 8 data bits in character participates in calculation of generated CRC. Start bit, stop bit and odd-even check bit don't participate in calculation of CRC. During generation of CRC, every 8-bit character is different from the value in register, then move the result to the direction of LSB by one bit while MSB position is zeroed. Then, extract and check LSB: if LSB=1, conduct exclusive-or calculation of value in register with a fixed prevalue (binary system 1010 0000 0000 0001 or hexadecimal: A001h). If LSB=0, don't conduct it. This process will be repeated until 8 times' shift is executed (one byte). After last times' (8th times) shift and related operations are completed, the next exclusive-or calculation of 8-bit byte with the current value of register will be implemented. Then, repeat it for 8 consecutive times like the abovementioned content. When bytes in message are calculated, the final value in register is obtained, namely CRC code. That is, the process of

CRC generation is:

- (1) Load 1 16-bit register into hexadecimal FFFFh (1), called CRC register.
- (2) Conduct exclusive-or calculation of the first 8-bit byte of the message with low byte of 16-bit CRC register. The result shall be put into CRC register.
- (3) Shift CRC register towards right (towards direction of LSB), MSB shall be zeroed. Extract and detect LSB.
- (4) If LSB=0: repeat step (3) and begin shift for another times.
If LSB=1, conduct exclusive-or calculation of CRC register and constant value A001h (1010 0000 0000 0001)
- (5) Repeat step 3 and 4, until 8th times' shift is finished. By then, the operation of the byte is finished.
- (6) Repeat step 2-5 for the next byte in message; continue the operation until all messages are processed.
- (7) Final content in CRC register is CRC check code.

7.2-8 Examples of information frame

Assuming the address of outer diameter measuring instrument (slave) is 01, all data shall be indicated with hexadecimal.

(1) Read measured outer diameter value

Request frame: 01 03 00 61 00 01 d5 d4

Response frame: 01 03 02 XX YY RR RR

In which, XX and YY are high and low bytes of measured outer diameter. RR RR are CRC check codes of 2 bytes. Thereupon concluded: measured outer diameter value= $256 \times (XX) + (YY)$. Unit is micronmeter (μm).

(2) Read nominal value of outer diameter

Request frame: 01 03 00 65 00 01 94 15

Response frame: 01 03 02 XX YY RR RR

In which, XX and YY are high and low bytes of measured outer diameter. RR RR are CRC check codes of 2 bytes. Thereupon concluded: measured outer diameter value= $256 \times (XX) + (YY)$. Unit is micronmeter (μm).

(3) Write nominal value of outer diameter

Requirement: write nominal value of outer diameter=6.000 mm = 6000 μm

(hexadecimal=1770h) into the instrument

Request frame: 01 06 00 65 17 70 97 c1

Response frame: 01 06 00 65 17 70 97 c1

(4) Write feedback control on

Request frame: 01 06 00 5d 00 01 d9 d8

Response frame: 01 06 00 5d 00 01 18 18

(5) Write feedback control off

Request frame: 01 06 00 5d 00 00 d9 d8

Response frame: 01 06 00 5d 00 00 18 18

7-2-9 Register address distribution

Read only parameters			Read and write parameters		
	One-dimension	Two-dimension		One-dimension	Two-dimension
0x31	Deviation alarm		0X65	Reference diameter	
0x5E	Y tested object position		0X66	Upper deviation	
0x5F	X tested object position		0X67	Lower deviation	
0X60	Reserve		0X68-0X6A	Reserve	
0X61	Measured outer diameter value (reading average outer diameter)		0X6B	Y-axis reference diameter	
0X62	Reserve		0X6C	Y-axis deviation	
0X63	X-axis measured outer diameter value		0x6D	Y-axis deviation	
0X64	Y-axis measured outer diameter value		0X92	Alarm output switch	
0X79	P parameter		0x5D	PID switch	
0X7A	I parameter				

7-3 MODBUSRTU-2 communication format

When the caliper communication CH-t (CH-t1) parameter is set to 2, 5, and 8, the device is in ModbusRTU-2 communication mode. 2 means that the transmitted byte has no parity, 5 means odd parity, and 8 means even parity.

Byte bits: 1 start bit, 8 data bits, the least significant bit is sent first, no parity, 1 odd/even parity bit, 1 stop bit (with parity), 2 Bit (when no verification).

Modbus communication is a master/slave communication protocol. There can only be one master device on a Modbus communication bus, but there can be multiple slave devices. Each slave device is distinguished by the slave address (ADD parameter on the caliper). When communicating on the ModbusRTU bus, each 8-bit byte in the information is divided into two 4-bit hexadecimal characters, and each information must be transmitted continuously.

When the diameter measurement instrument is used as a slave device for Modbus communication, it can be used to connect devices such as industrial computers, PLCs and touch screens that are compatible with this protocol. ModbusRTU communication message (including request message and response message) consists of the following parts:

Start	Address code	Function code	Data	Parity code	End
Postpone ≥ 3.5 bits	8-Bits	8-Bits	N x 8-Bits	16-Bits	Postpone ≥ 3.5 bits

7-3-1 Start structure and end structure

The start marks the beginning of a communication message frame, and the end marks the end of a communication message frame. They are generated by the sender of the message. The method is to leave the RS-485 bus idle for at least 3.5 bytes of transmission time. The individual data bytes in a communication message frame must be sent consecutively. If there is a gap of more than 1.5 bytes transmission time in a message frame, it will be discarded as an invalid frame.

At the receiving end, once it is detected that the bus is idle for 3.5 bytes of transmission time, it is considered as the beginning of a new communication message frame. In the process of receiving a message frame, once it is detected that the bus with a transmission time of 3.5 bytes is idle, it is considered that the message frame has been received. If a bus idle with a transmission time greater than 1.5 but less than 3.5 bytes is detected during the receiving process of the message frame, the message frame is discarded as an invalid frame, and the next start structure is restarted.

7-3-2 Address code

The address code (ie slave address) is the first data byte in the message frame transmitted in each communication. Standard ModbusRTU protocol supports slave address codes 1~247. The address range of QP series laser caliper is 0-127.

7-3-3 Function code

The function code is the second data byte in the message frame transmitted by each communication. The ModbusRTU communication protocol defines function codes as 1 to 127. QP series laser caliper uses the following function codes:

03 Read Holding Register: Read the holding register contents of one or more consecutive addresses.

04 Read Input Register: Read the input register content of one or more consecutive addresses.

06 Write Single Register: Write a 16-bit data to a holding register.

7-3-4 Data area

Function No. 03 (read holding register) requests the data area of the message frame to include 4 bytes:

Byte 3: The start address of the read register (high byte).

Byte 4: The start address of the read register (low byte).

Byte 5: Number of registers read (high byte).

Byte 6: Number of registers read (low byte).

The structure of the request frame and the data area of the response frame of function No. 04 is the same as that of function No. 03.

Address code	Function code	Register address	Register qty	Verification code
01	03/04	2 x 8-Bits	2 x 8-Bits	16-Bits

After the request command is executed normally, the data area of the returned response message frame includes 2N+1 bytes (N=the number of registers read):

Byte 3: The number of bytes of subsequent data (=2N, N can not exceed 6 and cannot overflow the address range)

Bytes 4 to 3+2N: N register values read (high byte first, low byte last)

Address code	Function code	Number of data bytes	Data	Verification code
01	03/04	1 x 8-Bits	2N x 8-Bits	16-Bits

The data area of the No. 06 function request message frame includes 4 bytes:

Byte 3: Register address (high byte).

Byte 4: Register address (low byte).

Byte 5: Register value to be written (high byte).

Byte 6: Register value to be written (low byte).

After the request command is executed normally, the returned response frame data area is exactly the same as the request frame.

Address code	Function code	Register address	Written register value	Verification code
01	03/04	2 x 8-Bits	2 x 8-Bits	16-Bits

7-3-5CRC verification code

ModbusRTU uses the CRC method to calculate the error check code. The CRC will check all data transmitted. It ignores the parity method of single character data in the message. The Cyclic Redundancy Check (CRC) field occupies two bytes and contains a 16-bit binary value. The CRC value is calculated by the transmitting device and then appended to the data frame. The receiving device recalculates the CRC value when receiving the data and then compares it with the value in the received CRC field. If the two

values are not equal, an error occurs.

In RTU mode, at the beginning of CRC, all 16 bits of the register are set to “1”, and then the data of two adjacent 8-bit bytes are put into the current register. Only the 8-bit data of each character is used to generate the CRC, and the start bit, stop bit and parity bit are not added to the CRC. When generating the CRC, each 8-bit byte is XORed with the contents of the register, and the result is shifted lower. The high bit is supplemented with “0”, and the lowest bit (LSB) is shifted out and detected. If it is 1, the register is XORed with a preset fixed value. If the lowest bit is 0, do nothing. The above process must be repeated until the eight shift operations are performed. When the last bit (the 8th bit) is shifted, the next 8-bit byte is XORed with the current value of the register material. Then another 8 shift XOR operations mentioned above need to be performed similarly. When all bytes in the data frame have been processed, the resulting final value is the CRC value.

The process of generating a CRC is:

Preset a 16-bit register as 0FFFFH (all 1s), which is called the CRC register.

XOR the first 8-bit byte in the data frame with the low byte in the CRC register, and store the result back into the CRC register.

Shift the CRC register one bit to the right, fill the highest bit with 0, move the lowest bit out and check.

If the lowest bit is 0: repeat step 3 (next shift). If the least significant bit is 1: XOR the CRC register with a preset fixed value (0A001H).

Repeat steps 3 and 4 until 8 shifts, thus processing a full eight bits.

Repeat steps 2 through 5 to process the next eight bits until all bytes have been processed.

The final value of the CRC register is the value of the CRC. When the CRC value is appended to the information, the low order bits come first and the high order bits come last.

7-3-6 Abnormal response frame

If an exception occurs during the execution of the request command, the slave will return an exception response frame with the following structure:

Start	Address code	Error code	Abnormal code	Verification code	End
Postpone ≥3.5 bites	8-Bits	8-Bits	8-Bits	16-Bits	Postpone ≥3.5 bites

Error code = original Function code + 128 (decimal) or +80h (hexadecimal). For example, corresponding to function request 03, its error code=83h (hexadecimal).

Exception codes are defined as: 01=unsupported Function code, 02=Register address error, 03=data error, 04=execution failure.

Example: Modbus read diameter value

Assuming that the address of the caliper is 1 (01H) and the current diameter is 6.234 (185aH), then:

Input: 01H 03H 00H 41H 00H 01H D4H 1EH

Diameter output: 01H 03H 02H 18H 5aH 32H 7FH

Some measurement data of the dual-axis one-dimension caliper (such as 140A, 280A, etc.) may be larger than that of the 65535 caliper, and the data is represented by two words (DWORD), so the address of the register will be changed accordingly.

Modbus stipulates that the register address starts from 1. Therefore, when communicating with the Modbus standard module, the Register address written by the standard module should be incremented by 1.

Read only		Read and write	
Register	Two-dimension	Register	Two-dimension
41H	average diameter	46H	Reference diameter
42H	X axis diameter	47H	Upper deviation preset
43H	Y axis diameter	48H	Lower deviation preset
44H	X axis position value	4aH	Buzzer switch
45H	Y axis position value	4bH	Average times
49H	PI control output	4EH-56H	Reserve
4cH	P parameter	4dH	I parameter
57H	X reference diameter	5aH	Y reference diameter
58H	X upper deviation preset value	5bH	Y upper deviation preset value
59H	X lower deviation preset value	5cH	Y lower deviation preset value

VIII. Overall Dimension

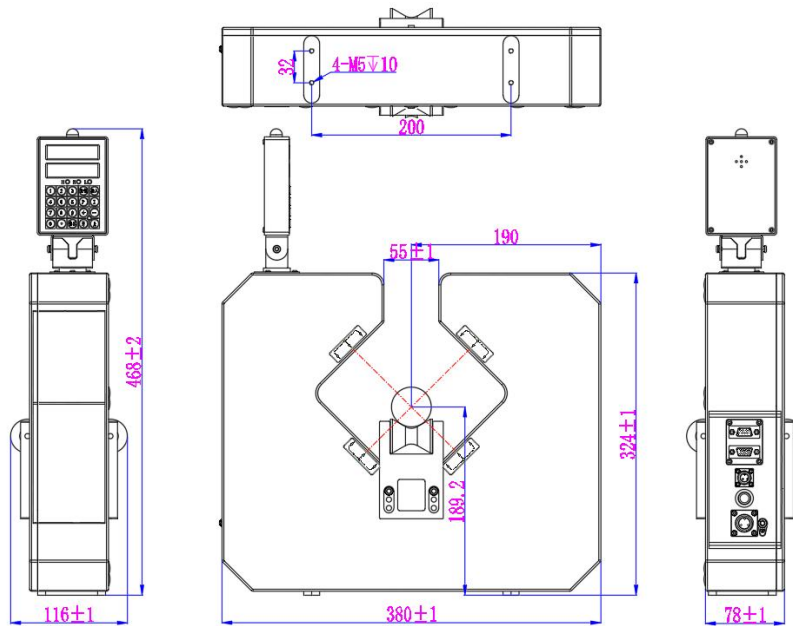

QP-安装支架:

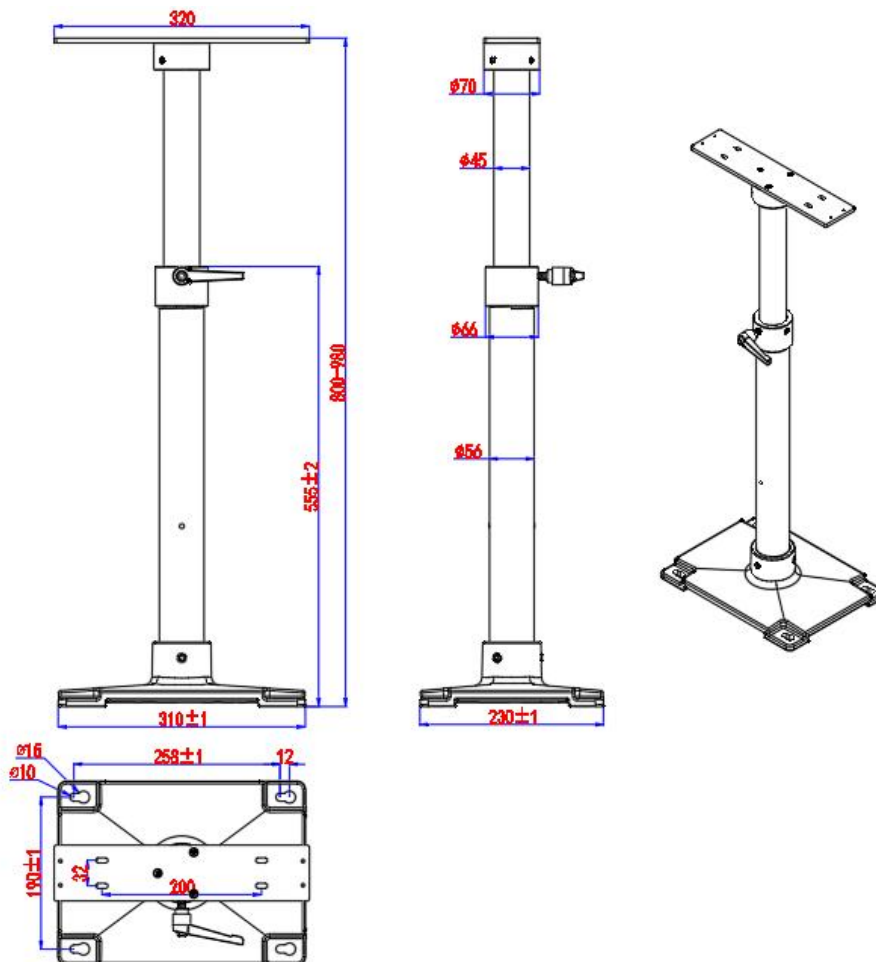

IX. Maintenance

1) When using diameter measuring instrument, it is necessary to pay attentions and keep protective lens of light inlet clean. In case of oil stain and dirt, it shall be wiped out with lens paper.

2) When the diameter measuring instrument is used for wire production line, drying treatment shall be done after the wire comes out of the water thank to prevent the precision from being influenced due to the water or water drop on the surface of wire in the measurement zone.

3) The standard rod shall be degreased with gasoline or alcohol and wiped out with lens paper or absorbent cotton before use every time and it shall be coated with rust protection after use.

4) Input voltage of diameter measuring instrument shall be kept within 180~260V.

X. Accessories

Power line -----	1
Standard rod -----	1
Cleaning ball -----	1
Lens paper -----	1
Connecting cable (the length is configured according to the user requirement)	1
Specification -----	1
Certificate of qualification -----	1

XI. After-sale Service

As of the date of shipment, in case of any faults in controller under the circumstance of rational storage and use within one year, our company will provide repair and exchange services. The right to interpret shall be reserved by our company.

In case of alteration of specification, the real object will prevail.